

Article number: 201461G302SW

Description: E+G Flanged linear actuator
GN146.1-G30-2-SW

Measures

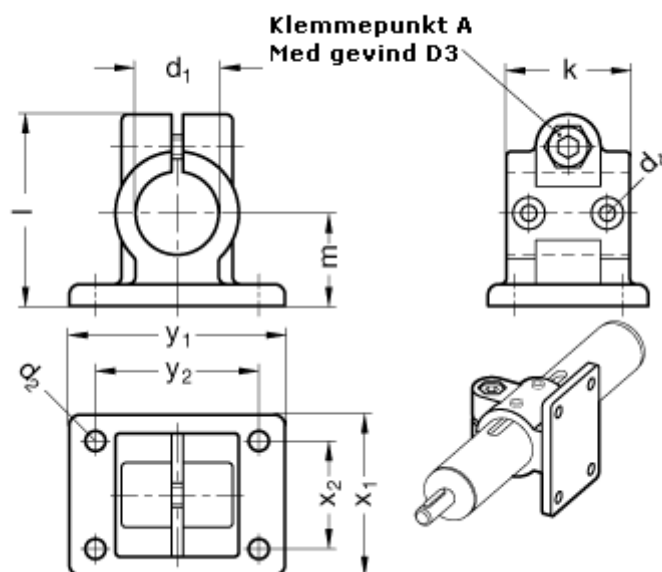

$d_1 = G30$	$x_2 = 35$
$d_2 = 6,5$	$y_1 = 70$
$d_3 = M 8$	$y_2 = 53$
$d_4 = M 4$	
$k = 40$	
$l = 62$	
$m = 30$	
$x_1 = 52$	